

# *FM Exciter*

*Model: FU-10830K*



*User Manual*

## CONTENTS

### **General Information**

The FU-10830K is the latest in a series of FM transmitter for demanding applications. It is especially suited for repeaters, audio and data links, packet radio, and remote control. The PLL-10830K was designed to provide a single-channel FM transmitter for transmit in the VHF bands.

### **Installation Mounting**

Some of support should be provided under the PC board, generally mounting the board with 8 holds. The transmitter board relies on the mounting hardware to provide the DC and RF output ground connections to the ground plane on the board.

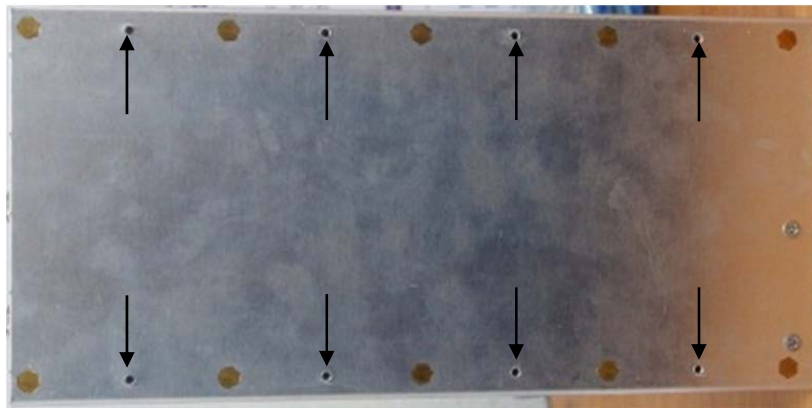

### **Electrical Connections**

Power supply should be connected to the connector on the PC board with #4 wire, which can be extended to a connector or feed through capacitors used on the cabinet in which it is installed. Be very careful not to route the wiring near RF components on the board, for instance underneath the board. The exciter operates VAC or VDC from 18 – 0 – 18 to 24 – 0 – 24 to at about 1000 mA peak with full RF output. A well-regulated power supply should be used. Be sure that the power source does not carry high voltage or reverse polarity transients on the line, since semiconductors in the transmitter can be damaged.

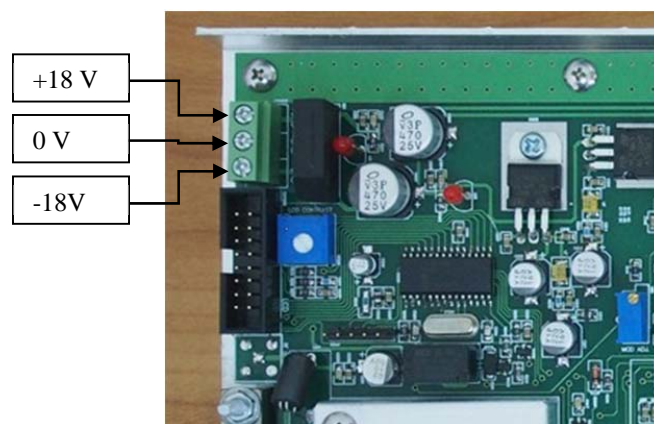

### Audio Input Connections

Be sure to observe polarity! Signal. You can connect audio to this transmitter.

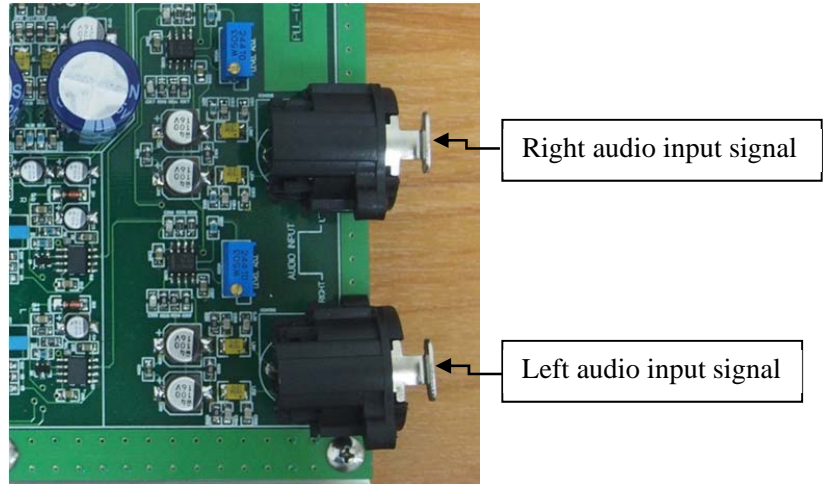

Connector type: XLR female

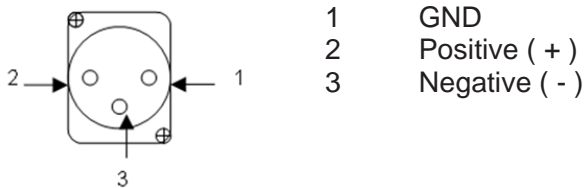

### RF Output Connections

The RF output connection should be made to the transmitter with a solder pad on transmitter (or SMA female on request). If you want to extend the RF output connection, we recommend using a short length of RG-316 coax with the plug and keep the pigtails very short.

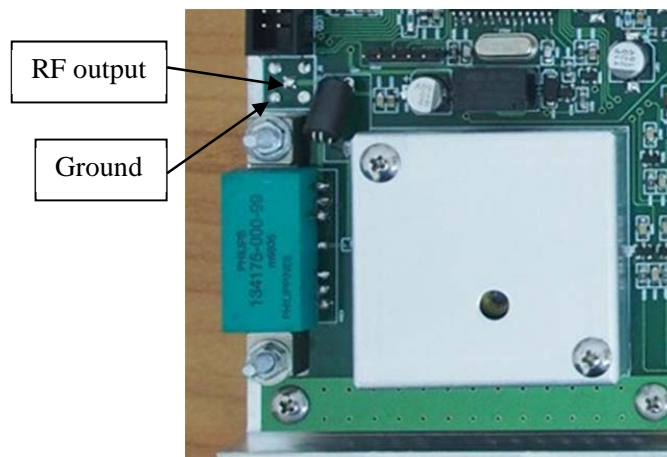

### LCD Connections

The LCD can display as 16x2 typical. You can connect to transmitter board.

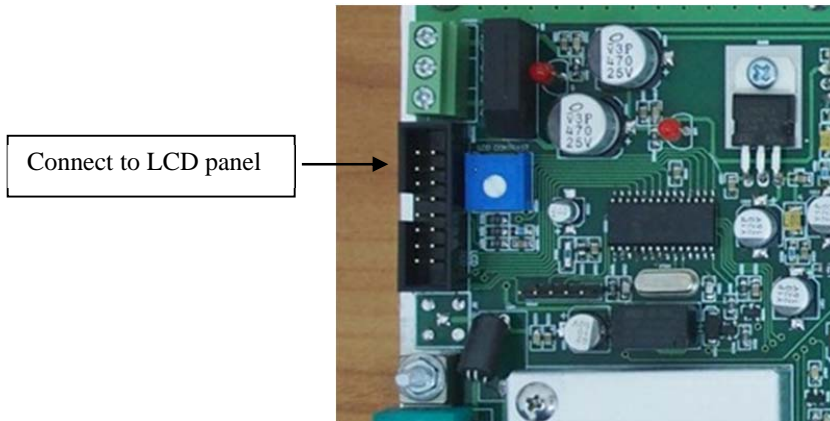

### LCD Panel

This is parameter display and control.

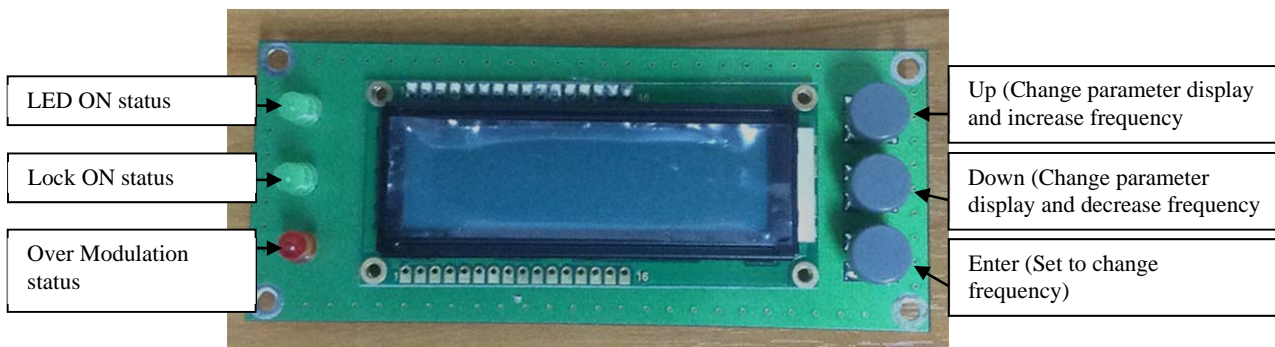

### Quick Specification Reference

- Operating frequency
- Model: PLL -10830K 87.50 – 108.00 MHz
- 
- RF Output: up to 0.5Watts
- Operating Power: 18 – 0 – 18 VDC at 1000 mA
- Size: 130mm. W x 270mm. D x 40mm. H

**Operation**

**Turn on**

Be sure that the power source does not carry high voltage or reverse polarity transients on the line, since semiconductors in the transmitter can be damaged. After you turn on, The LCD can be displayed as:

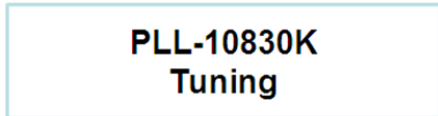

Then the LCD will displayed as:



To change the LCD displayed all parameter as:

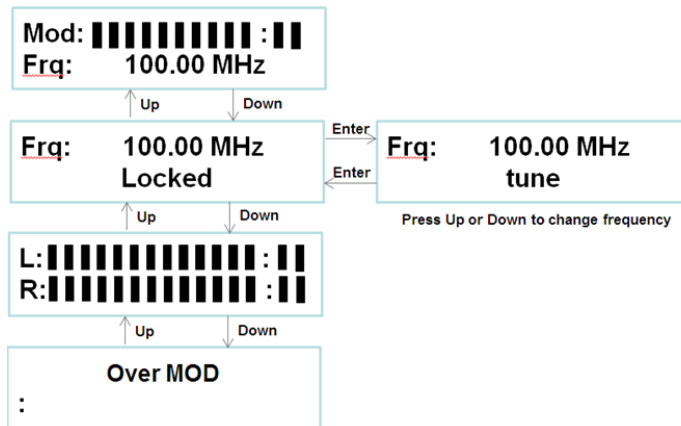

The PLL of transmitter will tune. After the PLL is locked to the frequency, LED will be displayed on LCD panel.

While the transmitter have audio input signal, LCD will be displayed as:



**Frequency Setting**

This menu lets you read and set the operating frequency.

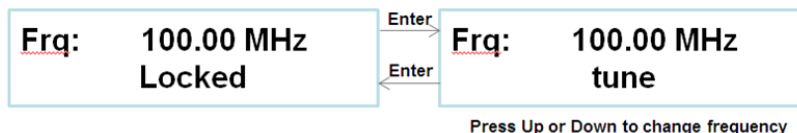

You can modify the set frequency using the UP (the frequency increases) and DOWN (the frequency decreases) push buttons. After having set a new frequency value, the exciter will release from the current frequency and it will latch onto the new operating frequency.

## **Adjustments**

### **Frequency correction**

The frequency from VCO will oscillator as frequency setting. The frequency can be error in the long time in use. You can adjustment to frequency correction by varicap as the picture as below.

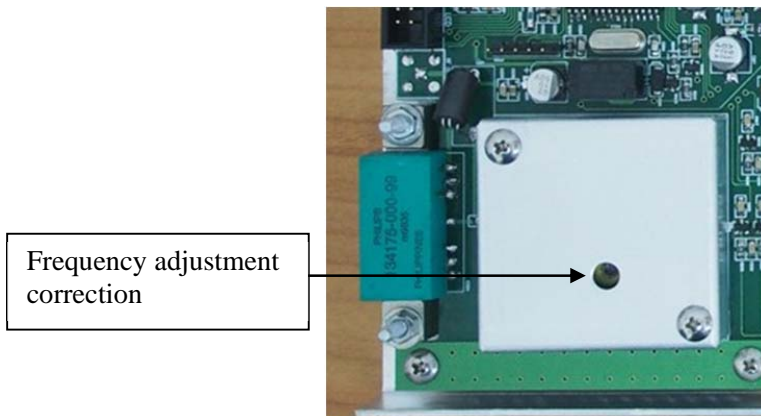

### **LCD contrast**

The LCD display can adjust the contrast as picture below:

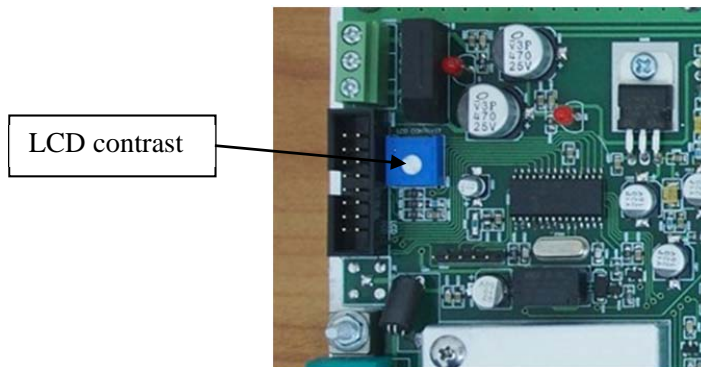

### **Modulation input signal adjustment**

You can adjust to modulation signal by potentiometer.

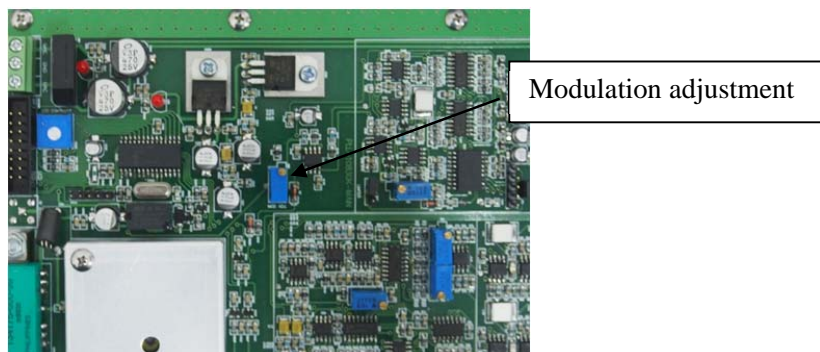

### Left and right input impedance

You can select to audio input impedance by resistor as below:

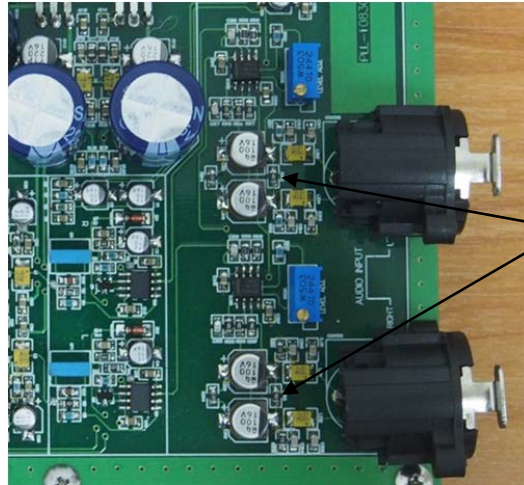

The factory set audio input impedance to 10Kohm. If you need to input impedance to 600 ohm, you will be removed SMD resistor 10kohm and replace to 600 ohm both left and right.

### Audio input signal adjustment

You can adjust to audio signal by potentiometer.

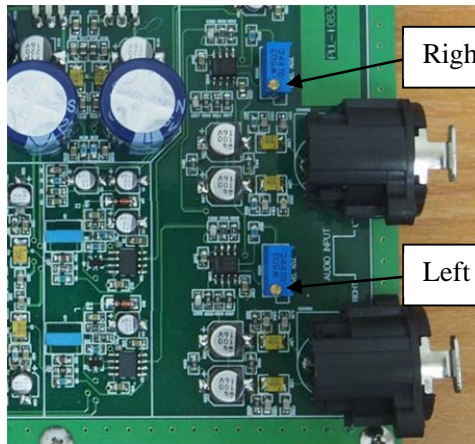

## **TROUBLESHOOTING**

### **General**

The usual troubleshooting techniques of checking dc voltages and signal tracing with an RF voltmeter probe, oscilloscope and spectrum analyzer will work well in troubleshooting the PLL-10830K. DC voltage charts and a list of typical RF output levels are given to act as a guide to troubleshooting. Although voltages may vary widely from set to set and under various operating and measurement conditions, the indications may be helpful when used in a logical troubleshooting procedure. The most common troubles in all kits are interchanged components, cold solder joints, and solder splashes. Another common trouble is blown transistors and IC's due to reverse polarity or power line transients. Remember if you encounter problems during initial testing that it is easy to install parts in the wrong place. Don't take anything for granted. Double check everything in the event of trouble.

### **Hum and Noise**

The VCO and loop filter are very sensitive to hum and noise pickup from magnetic and electrical sources. Some designs use a shielded compartment for VCO's. We assume the whole board will be installed in a shielded enclosure, so we elected to keep the size small by not using a separate shield on the VCO. However, this means that you must use care to keep wiring away from the VCO circuit at the right side of the board. Having the board in a metal enclosure will shield these sensitive circuits from florescent lights and other strong sources of noise. Because the frequency of a synthesizer basically results from a free running LC oscillator, the tank circuits very sensitive to microphones from mechanical noise coupled to the coil. You should minimize any sources of vibration that might be coupled to the transmitter, such as motors. Excessive noise on the dc power supply that operates the transmitter can cause noise to modulate the synthesizer output. Various regulators and filters in the Receiver are designed to minimize sensitivity to wiring noise. However, in extreme cases, such as in mobile installations with alternator whine, you may need to add extra filtering in the power line to prevent the noise from reaching the transmitter. Other usual practices for mobile installations are recommended, such as connecting the + power and ground return lines directly to the battery in-stead of using cigarette lighter sockets or dash board wiring.



**Quality control**

The FU-10830K are test from our lab. We guarantee to quality and reliable all products from our factory

**1. Frequency Error test ( < 500 Hz)**

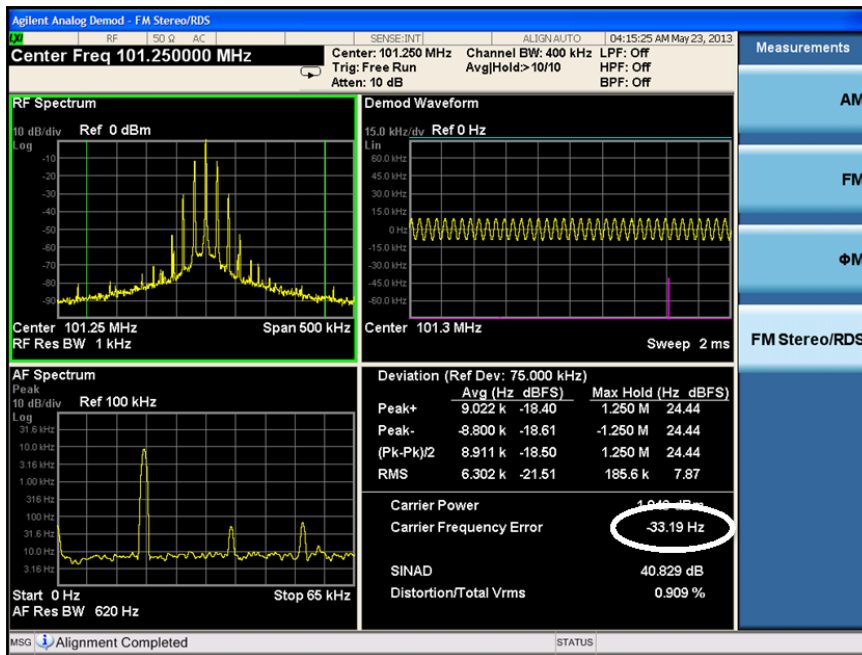

**2. Frequency Deviation test ( +/- 75 kHz (+-3% )**

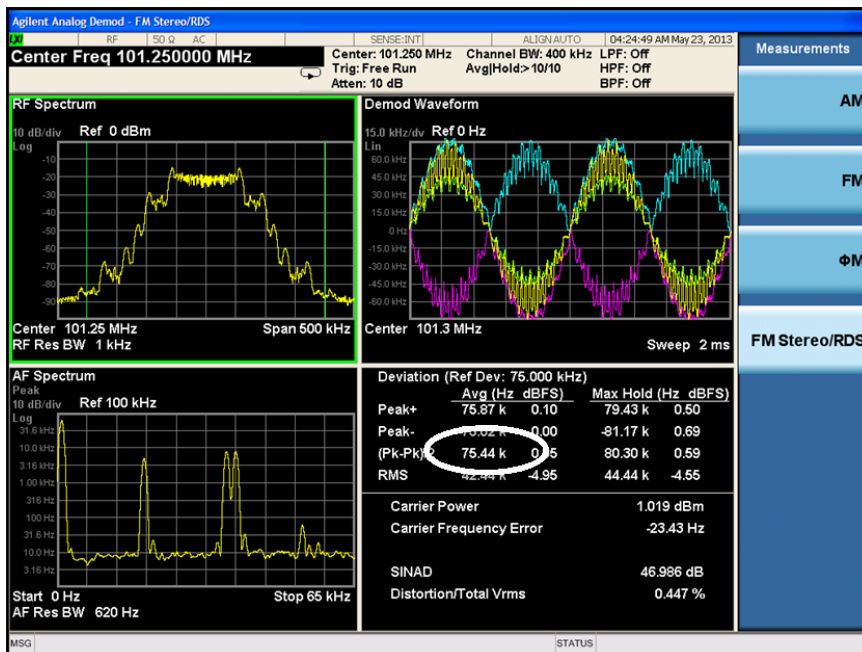

### 3. Out of Band Emission test

