

CZH618F-2000C 2KW

Digital FM Broadcast Transmitter User's Manual



FMUSER INTERNATIONAL GROUP INC.

<http://www.fmuser.net/>

Please notice this:

1.Read safety notice first.

2.A 50 dummy load(power rating 2KW)or antenna and cable(VSWR 1.30) must be connected before turning power on.

3.Please read System Control Logic section to fully understand how the system works.

4.Please read the Power On Sequence.

FMUSER 广州汉婷

Catalogue

Safety Notice

1.Overview-----	5
2.Technical Specifications-----	6
3.System Structure and Function -----	7
4. Test and Maintenance -----	10
5. Panel Function Description -----	10
6. Power on Sequence -----	13
7. System Control Logic-----	13
8.Description for software use-----	14
9.Indicator light -----	20
10. Failures Check -----	21

FMUSER 广州汉婷

Safety Notice

1. Please read the following safety points, in order to avoid the accidents and prevent the connecting machines to be broken.
2. Only the qualified maintenance workers can operate the service.
3. Prevent the fire and the bodily injury,
 - a. Use the proper wire. If not, it will cause the fire and the bodily injury;
 - b. Ensure the machine connect the ground. Please confirm whether the machine has connected the ground, through the wire and the lead, to prevent the electric shock;
 - c. Use the proper fuse. Please use the stipulated type and rating fuse;

Provide good ventilation. This machine adopts the natural convective radiation. Fix it correctly to keep it radiating well.

5. Please don't disassemble and repair by yourself when it's broken down. Please send to the professional service department to solve the problems.

CAUTION : Please don't assemble the machine in the moist environment;
Please don't assemble the machine in the easy exploding environment;
Please don't repair by yourself.

6. If you have any other questions, please connect with us: rita@fmuser.net

1. Overview

CZH618 digital FM broadcast transmitter, combining with audio modulation and 1KW power amplifier, is an excellent digital product that owns the highest and newest technology. The whole machine adopts the latest digital signal processing and the direct digital synthesized technology. This advantage provides us with excellent hearing feature which can match to CD audio quality.

CZH618 digital FM broadcast transmitter runs with perfect performance. Its technical specifications like THD; Audio Frequency Response; SNR and Stereo Separation etc. totally meet the national relevant standards and industry standards of FM transmitter. At the same time as the brand new high-tech digital products, in a number of their technical specifications is much higher than the national standards and industry standards.

CZH618 digital FM broadcast transmitter is composed of five parts: Power Supply, Main Control and Display Cell, Audio Processing and Frequency Synthesizing Cell, Power Control Center, and Power Amplifier Cell. It is fitted in the 4U, 19 inches standard case. All the output and input signal is lead from the back panel.

240 *64 liquid crystal as a display unit, displayed page is clear.

CZH618 series has password protected function to protect some important parameters from accidentally or incidentally changing.

CZH618 digital FM broadcast transmitter provides a serial communication interface, in order to build a Remote System easily.

CZH618 exciter has analog and AES/EBU audio interface and SCA interface(only two types are chose in three).AUDIO INPUT LEVEL -12dBm to +8dBm, Analog audio input impedance 600 Ω , AES/EBU Digital audio input impedance 110 Ω .

RTC function with which transmitter can be power on/off on time. are optional.

2. Technical Specifications

2.1 Equipment performance meet the following standard

GY/T 169—2001
 GB/T 4312.1-1984
 GB/T 4312.2-1984
 GB/T 12572-2008

2.2 Electrical Specification

Ø RF Frequency	87.00MHz ~ 108.00MHz Step 10kHz
Ø Output Power	Continuous adjustable to setting power
Ø Power Accuracy	<±10%
Ø Power stability	<±3%
Ø Output Impedance	50
Ø RF Output connector	L27-50K or L29-50K(7/16) or IF45-50K
Ø SFDR	<-60dB
Ø Residual Amplitude Modulation	< -50dB
Ø Carrier Frequency accuracy	±200Hz
Ø Frequency Stability:	1×10^{-6}
Ø Modulation Deviation	0~120KHz (100% ±75kHz)
Ø Pilot Frequency	19kHz±0.1Hz
Ø Pilot Amplitude	0~12KHz (10% 7.5K)
Ø Analog Audio Input Impedance	600 Balance
Ø Digital Audio Input Impedance	110 Balance (optional)
Ø Digital Audio Input Level	0.2 ~ 10Vpp (optional)
Ø Digital Audio Sample Rate	30kHz ~ 96kHz (optional)
ØSCA Input	imbalance
ØSCA Connector	BNC Type connector
Ø SCA Modulation degree	7.5KHz (0dBm)
ØSCA Centre frequency	67KHz
ØSCA frequency deviation	±4KHz
Ø Audio gain	-15dB~+15dB step 0.1dB
Ø Pre-emphasis	0µs、50µs、75µs
Ø Frequency Response	< ±0.1dB , 30Hz ~ 15000Hz
Ø LR Channel Level Difference	< 0.1dB (100% Modulation)
Ø Stereo Separation	> 50dB (type.) , 30Hz ~ 15000Hz
Ø SNR	> 70dB(type.) , 1kHz 100% Modulation
Ø Distortion measure heavier,Not to heavy)	< 0.1% (30Hz ~ 15000Hz , 100% modulation,No
Ø Heat dissipation	Forced ventilation
Ø Power Supply	AC88V~AC264V 47Hz~63Hz

2.3 Physical Specification:

Chassis standards	19 Inch
Casing Size	4U (445mm×170mm×700mm)
Weight	40kg±2kg
Ambient temperature	5 ~ +40
Relative Humidity	< 95%
Sea Level Height	< 4500m

3. System Structure and Function

CZH618 digital FM broadcast transmitter is composed of five parts: Power Supply, Main Control and Display Cell, Audio Processing and Frequency Synthesizing Cell, Power Control Center, and Power Amplifier Cell (it is showed by Figure 3-1).

The Power Supply changes the 220V AC to all kinds of DC for other parts of transmitter.

Main Control and Display Cell is an interface between users and the machine. It puts all information about transmitter on the LCD, and users can configure the transmitter via pressing the key buttons.

Audio Processing and Frequency Synthesizing Cell is the core of the transmitter, This part does pilot stereo code, pre-emphasis, and audio gain for inputting audio signal which can be analog or AES or SCA by using digital signal process technology, and meanwhile, it using direct digital synthesis technology to get frequency which users want.

Power Amplifier Cell contains Driver, Power Distribute, Amplifier, Power Combiner, Filter, Power Monitor.

Power Control Center Controls output RF power at a value form Main Control and Display Cell, according as sampling value of power, voltage, current, temperature. At the same time, it sends sampling value to Main Control and Display Cell to display.

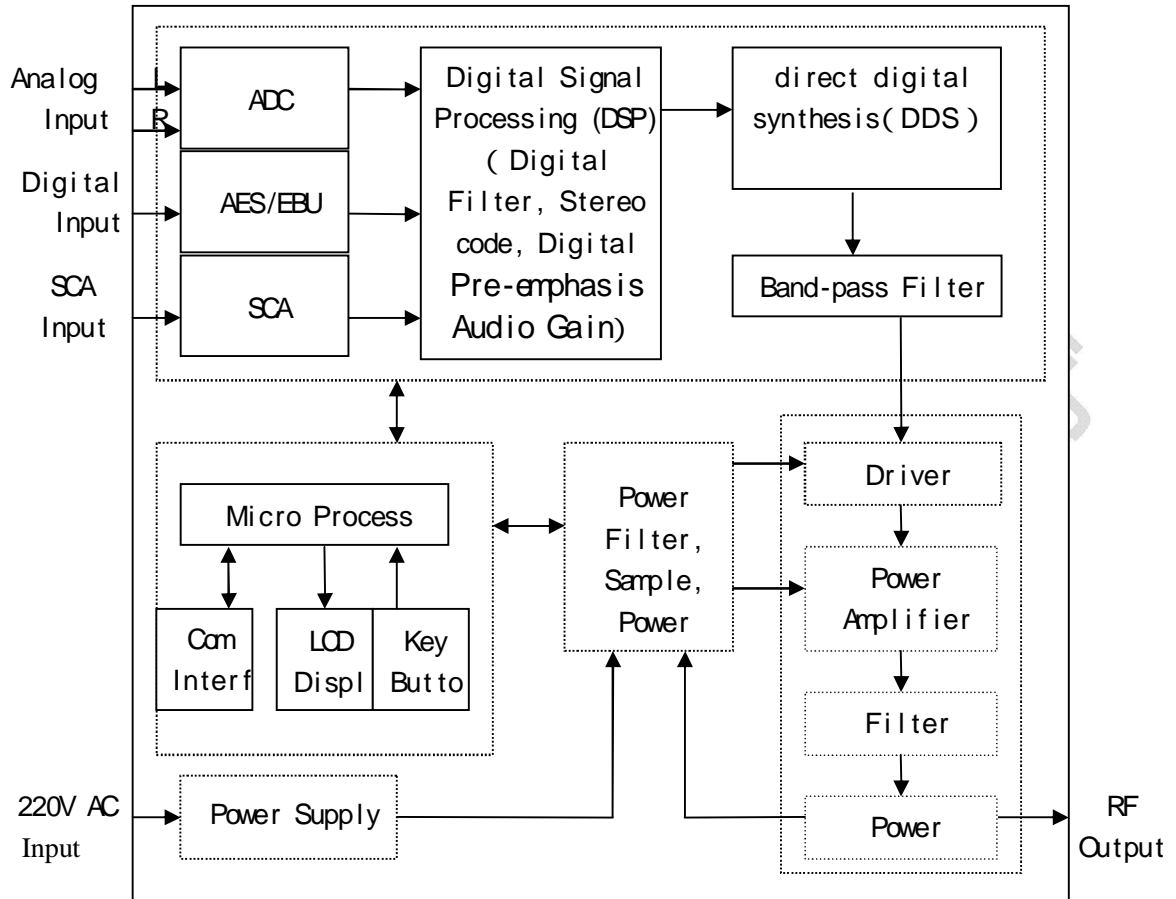

Figure 3-1 CZH618F-2000C 2000W transmitter structure and function

4. Test and Maintenance

CZH618F-2000C Digital FM Transmitter is a high performance Transmitter, its Technical Specifications are complete meet FM Transmitter's National Standard & Industry Standard, and as a new type of high-tech Digital Product, a lot of its Technical Specifications are better than National Standard & Industry Standard.

4.1 Performance Test

CZH618F-2000C Digital FM Transmitter is the Compact product. So it only needs One-Time Testing of the Entire Machine, if the testing report doesn't meet its technical specifications by the same accuracy instrument, please repair it in professional department or original manufacturer.

4.1.1 Audio Performance Test

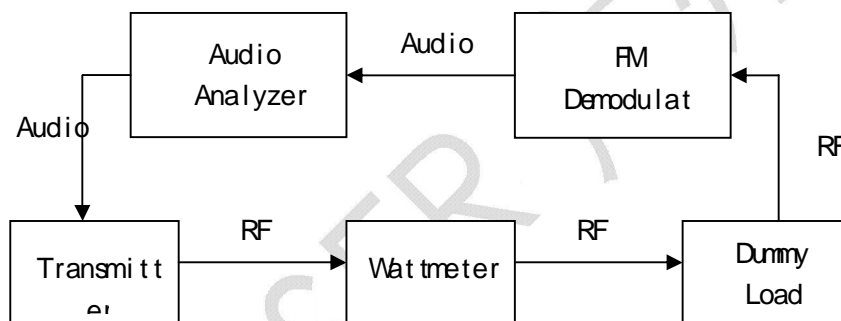

Figure 4-1 connecting for audio analyze

- a. Connect transmitter and test Instrument with cable according Figure 4-1.
- b. Make audio analyzer output 400Hz, 0dBm;
- c. Finely adjust audio output level until demodulation reaches 75KHz (100% modulated) ;
- d. Scan audio output frequency from 30Hz to 15kHz, record frequency response ($< \pm 0.1\text{dB}$) and distortion ($< 0.1\%$);
- e. Scan audio output frequency from 30Hz to 15kHz, record stereo separation (typical $> 50\text{dB}$);
- f. Set audio analyzer to 1kHz, exciter pre-emphasis to $50\mu\text{s}$, demodulator to $50\mu\text{s}$ de-emphasis, adjust audio analyzer power output until demodulation reaches 75KHz , record mono SNR($>75\text{dB}$) and stereo SNR ($>70\text{dB}$).

4.1.2 Carrier Frequency Accuracy Test

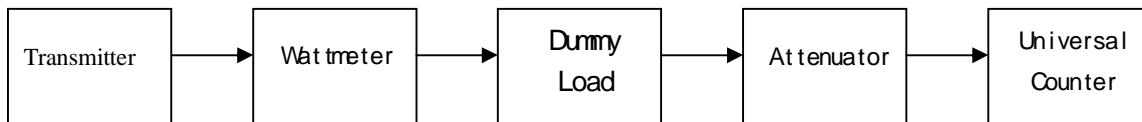

Figure 4-2 connecting for carrier frequency test

- a. Connect the test instrument to transmitter according to Figure 5-2;
- b. The test carrier frequency accuracy ($\pm 200\text{Hz}$).

4.1.3 Harmonic Suppression

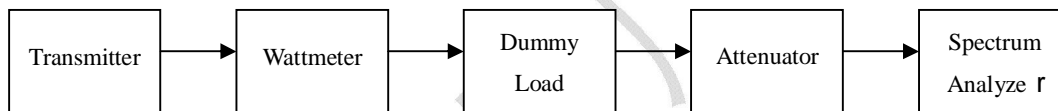

Figure 4-3 connecting for spectrum analyzer

- a . Connect the test instrument to transmitter according to Figure 5-3;
- b . Record harmonic suppression relative to carrier ($< -60\text{dB}$).

4.2 Maintenance

It needs to use new fans instead of the old ones which have worked more than 15000 hours. If the digital FM broadcast transmitter works at a very dirty environment, for example a place with much of dust, it must be to replace fans ahead of schedule.

5. Panel Description

5.1 Front Panel



1—— LED Indicator

ON power supply indicator ;

RF. RF power out;
STEREO stereo indicator;
REMOTE remote control is on.
TEMP temperature alarm.

VSWR VSWR is high.

GENERAL PA Voltage or PA Current system alarm;
RF MUTE inter-lock in or excessive forward power or
excessive reflect power.

2—— LCD display screen

3—— Operation button

UP: up or increase

ENTER: enter

DOWN:down or decrease

4—— Power switch

5.2 Back Panel

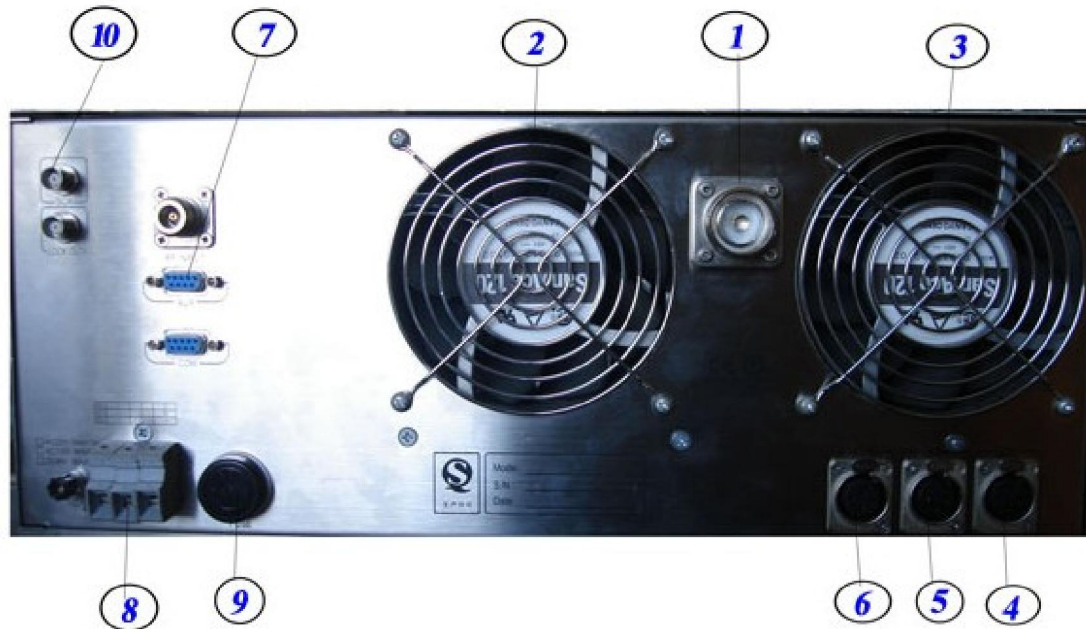

Back Panel function description:

- 1 — RF Output
- 2 — Axial Fan for Rf power heat sink
- 3 — Axial Fan for power supply
- 4 — Left Analog Audio Input
- 5 — Right Analog Audio Input
- 6 — AES/EBU Input (optional)
 - 1---GND ;
 - 2---positive ;
 - 3---negative ;
- 7 — COM RS232
 - PIN 2---TX
 - PIN 3---RX ;
 - PIN 5---GND ;

- 8 — AC Socket
 - PIN1----L ;
 - PIN2----GND
 - PIN 3----N ;
- 9 — Fuse Socket with 25A .
- 10 — RF Test Port

6. Power On Sequence

- 6.1 Open the package, check appearance, switch, key button, socket, and interface port on front and back panels.
- 6.2 Turn power switch on the “OFF” position and connect power cord to power source.
- 6.3 Connect RF out port to a 50 Ohm dummy load or antenna through a cable.
- 6.4 Turn power on.
- 6.5 Set RF logical control (see detail in System Logic Control).
- 6.6 Set RF power.
- 6.7 Set parameters such as frequency, digital/analog audio input select, stereo/mono select, audio gain, modulation deviation, pre-emphasis.
- 6.8 Turn on RF power.

7. System Control Logic

7.1 RF Output Control

The RF output of CZH618F-2000C digital FM broadcast transmitter is controlled by switches: RF Switch in main menu and period control switch in RTC menu.

RF Switch:

When RF Switch is off, turn off RF power.

When RF Switch is on and Period Control is disabled, turn RF power on to setting power.

When RF Switch is on and Period Control is enabled, RF power is controlled by Period Control function (see Period Control).

Period Control:

When RF Switch is on and Period Control is enabled, the control method is as follow:

The system reads current time through RTC and check whether current time is falling into any of the three periods. If yes; turn on RF power to its setting power. Else turn off RF power. A period is invalid if start time is greater than or equal to end time. Current time will never fall into an invalid period. If three periods are all invalid, turn RF power off for ever.

7.2 Remote Control

Remote control is set in <SET> menu. When remote control is enabled, remote LED on front panel is lit and parameters are controlled by remote host and can not be changed locally except "Remote" flag in <SET> menu. Updated parameters will be automatically stored in EEPROM.

When remote is disabled, remote host can not control over the exciter but locally does. Updated parameters will be automatically stored in EEPROM.

RS232 or RS485 are used for remote control. Before enabling remote control, baud rate and device address should be properly set.

7.3 Change RF Frequency

After RF frequency changed, RF power will drop to 0 first, and then increase to its setting power.

7.4 Time Period Modification

It is suggested that disable Period Control before correcting date and time or changing period's start and end time to avoid instantaneous undesired RF power on and off.

7.5 System Protection

In some urgent cases such as exceeded forward power, reflect power, current and over temperature, system will reboot. If it is failed successive 3 times, the system will automatically turns off RF power and just acts display function.

System will also shut down when some main parameter can not be set such as frequency, digital/analog audio select.

8. Direction for Software Use

8.1 General Description

8.1.1 Buttons

UP: Up or increase, when pressed and held for a longer time, it speeds up.

DOWN: Down or decrease, when pressed and held for a longer time, it speeds up.

ENTER: Enter, used to select menu and enter edited parameter.

8.1.2 Menu classification

There are three kinds of menus: display menu is display only menu; select menu used to select sub menu or goes back to its main menu; edit menu used to enter parameters or configure the system.

How to enter parameter

Just scroll highlight bar to desired edit item and press ENTER, use UP or DOWN to change parameter and press ENTER again to save it. Some important parameter or operation may need further confirmation. In this case, a “Y” or “N” will appear after editing at the end of the edit line. Use UP or DOWN to select “Y” (confirm) or “N” (cancel) and press ENTER to save updated parameter or cancel it.

Parameter can not be modified locally when remote is enabled except “Remote” itself.

8.1.3 Return to Main Menu

When there is no operation (press button) for a long time, system will return to its main menu automatically with LCD backlight off. Not saved updated parameter will be replaced with its old value.

8.1.4 LCD backlight

LCD backlight will be automatically turned off when there is no operation for a long time and turned on immediately when any key is pressed.

8.2 Pages Description

8.2.1 System Boot Up

8.2.2 Setting parameter display

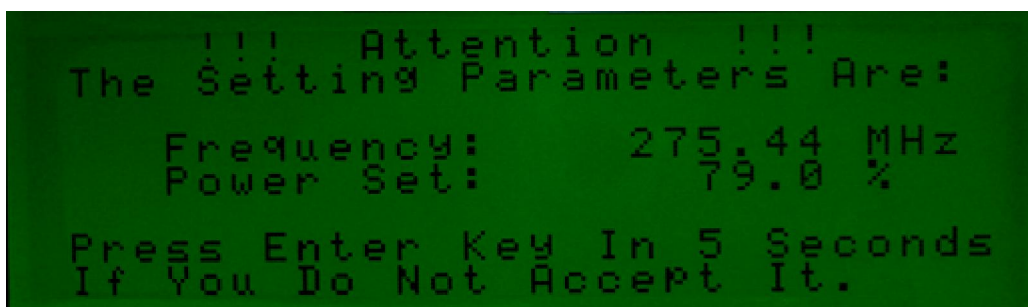

```
!!! Attention !!!
The Setting Parameters Are:
Frequency:      275.44 MHz
Power Set:     79.0 %
Press Enter Key In 5 Seconds
If You Do Not Accept It.
```

Figure 8-2 The Page displaying setting parameters

Frequency and Power set percent, the most important setting parameters, appear in this page. after that, when this page is disappeared ,the system will slowly increase output power; if users do not accept these two parameter, it's should to keep any of the keys in push more than 5 seconds, then when it enters the main menu page, in will not to transmit any power.

8.2.3 Main menu page



Figure 8-3 Main menu page

Figure 8-3 shows main menu page. The audio bar displays at the left of the page. The scale means modulation deviation.

This page contains the parameter as following:

RF SWITCH:	RF switch control	select between ON or OFF.
FWD POWER:	forward power	display only.
RFL POWER:	reflected power	display only.
FREQUENCY:	RF frequency	display only.
AUD GAIN:	left and right audio gain	display only.
[VIEW]	parameter data browse menu, see [VIEW] menu.	
[STATUS]	system running status, see [STATUS] menu.	
[SET]	parameter setting menu, see [STATUS] menu.	

8.2.4 Page of VIEW



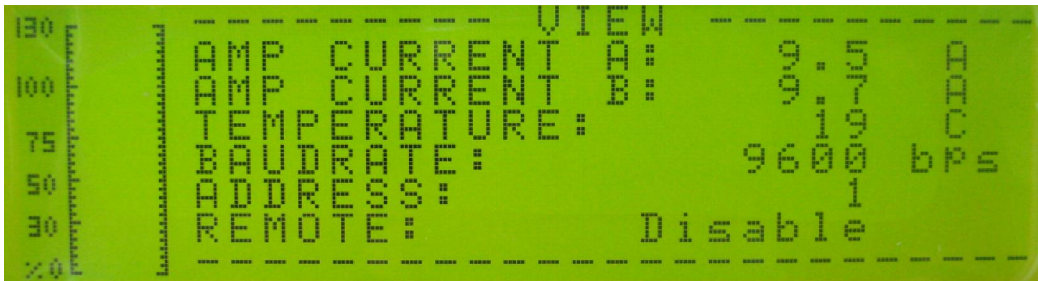
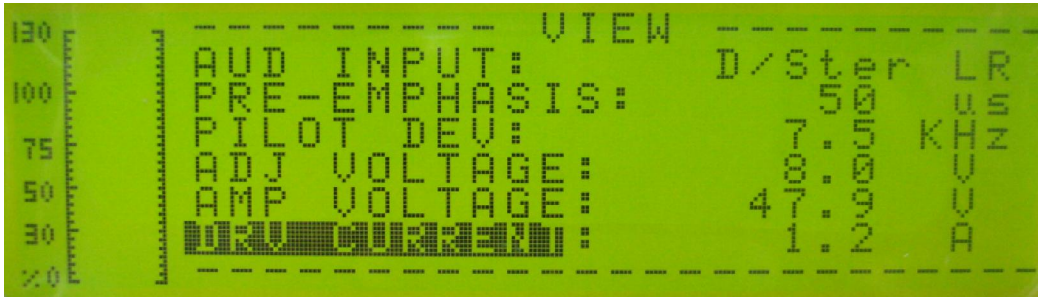

Figure 8-4 Page of VIEW

Figure 8-4 shows the all parameters in the VIEW page. In the VIEW page, users can only browse the parameters. If users want to modify the parameters, it should be enter the SET page.

FWD POWER :	Forward power.
RFL POWER:	Reflected power.
FREQUENCY :	RF frequency.
MODU DEV:	modulation deviation.
AUD GAIN:	audio gain.
AUDIO INPUT:	audio input and modulation mode, see [Set] menu.
PRE-EMPHASIS:	pre-emphasis.
PILOT DEV:	pilot deviation ;
AMP VOLTAGE:	amplifier voltage (48V in normally).
DRV CURRENT:	current of driver amplifier.
AMP CURRENT A:	current of amplifier module A.
AMP CURRENT B:	current of amplifier module B.
AMP CURRENT C:	current of amplifier module C.
AMP CURRENT D:	current of amplifier module D.
TEMPERATURE:	temperature of amplifier
BAUDRATE:	baud rate used for serial communication.
ADDRESS:	device address used for remote control.
REMOTE:	remote control switch.
DATE:	date
TIME:	time.
PERIOD CTRL:	period control.
[EXIT]	return to its parent menu.

8.2.5 Page of STATUS

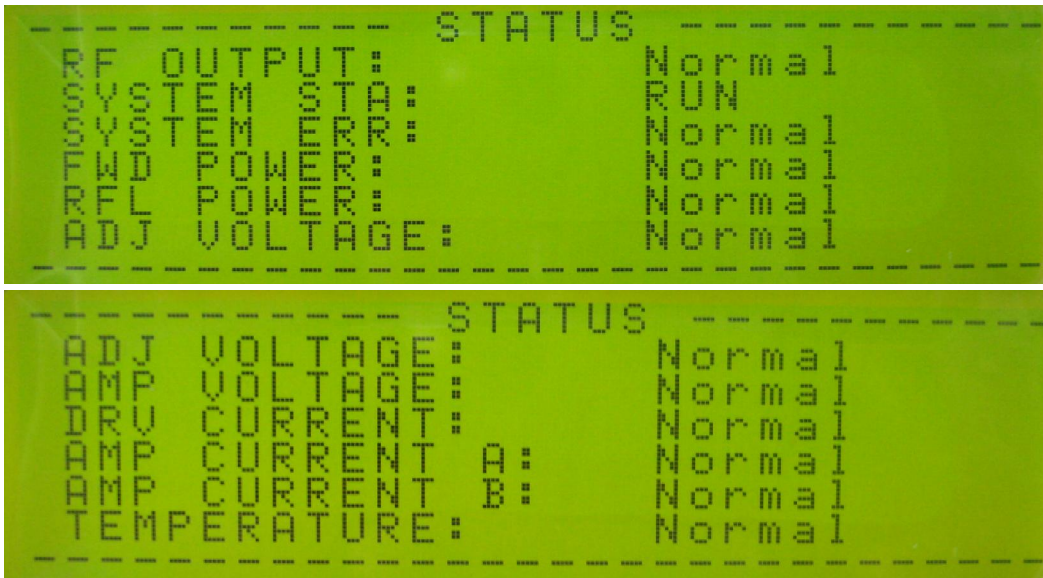

Figure 8-5 Page of STATUS

Two pictures in Figure 8-5 show the status of all parameters, users can find out the system is running normally or not.

RF OUTPUT: Normal/OFF/Drop; Refer to control logic section.

Normal: RF output is in normal status.

OFF: RF power is off.

Drop: RF power can not achieve to its setting power.

SYSTEM: Normal/Error

Indicate system errors. Contact equipment provider when error happens.

FWD POWER: Normal/Warning/Protect

Normal: forward power is normal.

Warning: forward power is higher than setting power.

Protected: forward power is too high, RF power is turned off.

RFL POWER: Normal/Warning/Protect/Protect H

Normal: reflect power is normal.

Warning: reflect power is high, may cause RF power drop.

Protected: reflect power is too high, RF power is turned off.

AMP VOLTAGE: Normal/Warning/Protect

Normal: amplifier voltage is normal.

Warning: amplifier voltage is high, may cause RF power drop.

Protected: amplifier voltage is too high, RF power is turned off.

DRV CURRENT: Normal/Warning/Protect

Normal: amplifier driver current is normal.

Warning: amplifier driver current is high, may cause RF power drop.

Protected: amplifier driver current is too high, RF power is turned off.

AMP CURRENT A: Normal/Warning/Protect

Normal: amplifier module A current is normal.

Warning: amplifier module A current is high, may cause RF power drop.

Protected: amplifier module A current is too high, RF power is turned off.

AMP CURRENT B: Normal/Warning/Protect

Normal: amplifier module B current is normal.

Warning: amplifier module B current is high, may cause RF power drop.

Protected: amplifier module B current is too high, RF power is turned off.

AMP CURRENT C: Normal/Warning/Protect

Normal: amplifier module C current is normal.

Warning: amplifier module C current is high, may cause RF power drop.

Protected: amplifier module C current is too high, RF power is turned off.

AMP CURRENT D: Normal/Warning/Protect

Normal: amplifier module D current is normal.

Warning: amplifier module D current is high, may cause RF power drop.

Protected: amplifier module D current is too high, RF power is turned off.

CUR BALANCE: Normal/Warning/Protect, status of unbalance current between 4 amplifier modules.

Normal: unbalance current is normal.

Warning: unbalance current is big, may cause RF power drop.

Protected: unbalance current is too big, RF power is turned off.

TEMPERATURE: Normal/Warning/Protect

Normal: temperature is normal.

Warning: temperature is high, may cause RF power drop.

Protected: temperature is too high, RF power is turned off.

8.2.6 PASSWORD CHECK

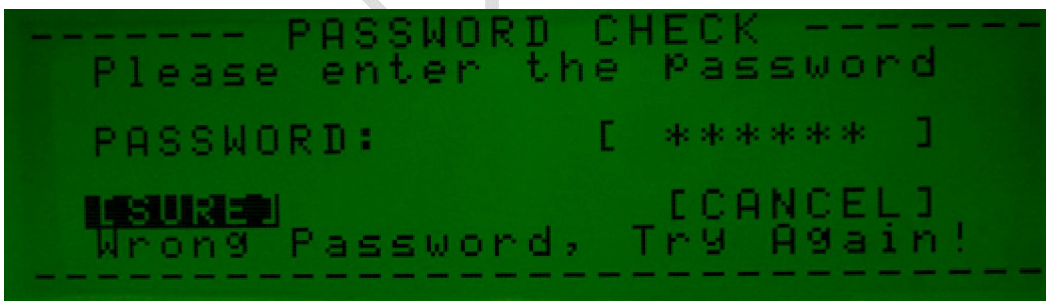

Figure 8-6 Page of password check

Check password before entering [Set] and [Preset] menu When Password Check is enabled. Enter password in "Password" first, and then select [Sure]. If correct password is entered, it will enter to desired menu. Else it will display "Wrong password, try again".

Select [Cancel] to give up password enter and return to its previous menu.

The initial password is "000000", if need a new password, refer to "Password" menu.

8.2.7 SET Menu



Figure 8-7 SET menu

Audio bar is located on the left side of the screen, it indicates dynamic modulation deviation. 100% denotes 75KHz modulation.

Broadcast: broadcast parameter setting, see “Broadcast” menu.

General: system parameter setting, see “General” menu.

Password: change password menu, see “Password” menu.

Preset: load default parameters, see “Preset” menu.

8.2.8 BROADCAST Menu



Figure 8-8 Page of BROADCAST Menu

FWD Power: forward power, display only, used to watch real output power when adjusting output power percentage.

RFL Power: forward power, display only, used to watch real output power when adjusting output power percentage.

Power Set: set the percentage of output power.
 Frequency: set RF frequency.
 Modu Dev: set modulation deviation.
 Aud Gain L: set left audio gain.
 Aud Gain R: set right audio gain.
 Audio Input: D/Mono mono modulation, audio from left digital channel.
 A/Mono mono modulation, audio from left analog channel.
 D/Ster stereo modulation, audio from digital channel.
 A/Ster stereo modulation, audio from analog channel.
 Pre-emphasis: select pre-emphasis.
 Pilot Dev: set pilot deviation.

8.2.9 GERNERAL Menu

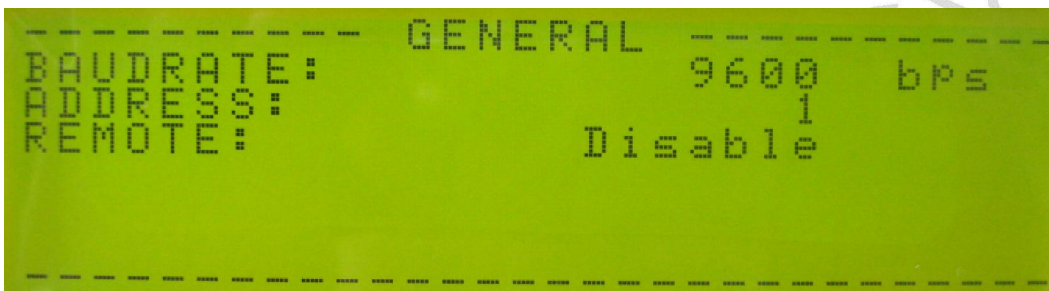

Figure 8-9 Page of GERNERAL Menu

Baud Rate: select baud rate for remote control.
 Address: set device address for remote control.
 Remote: enable or disable remote control.
 [EXIT] return to its parent menu.

8.2.10 PRESET Menu



Figure 8-10 Page of PRESET Menu

[Preset] menu is used to load default parameters. Make sure that some parameters may need to be adjusted after Preset according to your broadcasting requirement.

Select [Sure] to load default parameters. Select [cancel] to return to Main menu.

Preset default parameters:

Frequency: 97.50 MHz

Power Percentage:	0.0%
Audio Gain:	0 dB
Audio Input:	Digital audio, stereo modulation.
Pre-emphasize:	50 us
Modulating deviation:	75.0 KHz
Pilot deviation:	7.5 KHz
AGC:	enable
Baud rate:	9600 bps
Address:	0
Remote:	OFF
Period Control:	OFF
Password:	000000

8.2.11 PASSWORD Menu



Figure 8-11 Page of Password set

Change password: enter new password in “New” edit box, and enter the same new password again in “Again” box. If two enters are the same, it will display “change password successful”, else display “Different password, try again!”. Just select [EXIT] if do not want change password. The initial password is “000000”.

Password Control : Enter [Set] and [Preset] menu need password checking when Password Control is “ON”; there is no password check when Password Control is “OFF”. [EXIT] return to its parent menu.

9. Indicator light

At the left side of the front panel, there are 8 LED lamps used to indicate all kind of system status. Three of them are green, one is yellow, and the other four is red. If one of the red lamp is light, it means that there is something wrong, users can find out the problem at the [STATUS] menu.

9.1 Lamp for Power on

When it is power on, the voltage of 5V is supplied normally, this green lamp is luminous.

9.2 Lamp for RF

When the RF SWITCH in the main menu is set to “ON”, and the POWER SET percent is more than 0, this green lamp is light.

9.3 Lamp for AUDIO

If the audio input mode is set to be the stereo, the lamp is light.

9.4 Lamp for REMOTE

In the page of General Set, if Remote is enabled, this yellow light is illuminant.

9.5 Lamp for TEMP

When the amplifier temperature is higher than 60 , the red lamp is light; if temperature exceeds 65 , it will power off automatically. Users can enter [STATUS] page to view TEMPERATURE alarm status.

9.6 Lamp for VSWR

If reflected power is higher than 5% of rated power, the lamp is light; if it is higher than 8% of power, it will decrease output power to decrease reflected power; when it is higher than 10% of power, it may happen that: the software power off the output, or the hardware circuit switch off the power supply, then power on again.

9.7 Lamp for GENERAL

If this lamp is light, it may happen that: forward power is more than 105% of rated power, voltage of power supply is higher than 53V or lower than 45V, driver current is higher than 2.2A, at least one amplifier's current is higher than 18A, and one amplifier has no current.

When the lamp is light, and accompanied by a power decreases, it shows that the reflection power is too big. In a certain period of time, reduce power still can not get out of this state, the system will shut down and restart the amplifier.

If forward power exceeds 110% of rated power, the system will shut down the amplifier immediately, and then restart it.

Users can enter **【STATUS】** page to check the alarm status of FWD POWER , ADJ VOLTAGE , AMP VOLTAGE , DRV CURRENT , AMP CURRENT A , AMP CURRENT B.

9.8 Lamp for RF MUTE

It means nothing for this mode of equipment.

10. Failure Check

10.1 Turn on the power supply, but the equipment doesn't work

it may :

The fuse is broken: change the fuse;

The plug is not inserted tightly or contacted fault: insert the plug tightly.

10.2 No audio output

The source of audio signal is not connected: check the wire to ensure it has been connected correctly.

Choose the wrong source of the signal: please choose the correct source of signal, digital or analog.

10.3 Other Failure

If there is any other problem that can not be solved, please contact with Zhongchuan digital equipment Co., Ltd.